

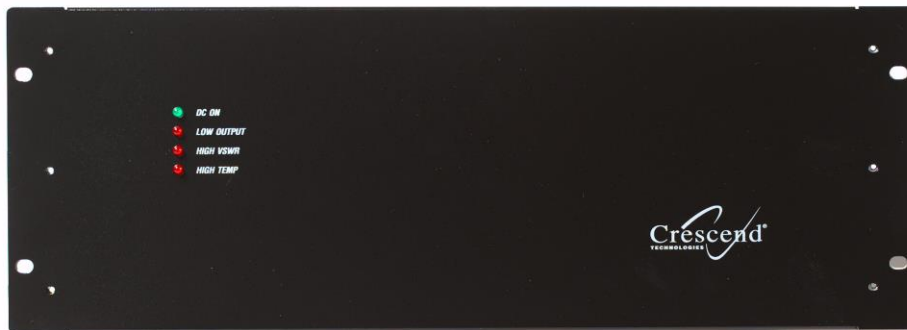

## INSTALLATION AND SERVICE MANUAL

### **C5 SERIES, 48V CONTINUOUS DUTY POWER AMPLIFIER**



Crescend Technologies  
100 High Grove Blvd  
Glendale Heights, IL 60139

Phone: 847-908-5400  
Fax: 847-908-5408  
Email: [sales@CrescendRF.com](mailto:sales@CrescendRF.com)  
Web Site: [www.CrescendRF.com](http://www.CrescendRF.com)



# TABLE OF CONTENTS

## Section 1

Par. No.	General Description	Page No.
1.1	Introduction	4
1.2	General Description	4
1.3	Functional and Physical Specifications	5
1.4	Equipment Changes	5

## Section 2

### Installation

2.1	Introduction	8
2.2	Electrical Service Recommendations	8
2.3	Unpacking and Inspection	8
2.4	Installation Instructions	9
2.5	Amplifier Summary Alarm and Power Cutback Control	10

## Section 3

### General Operating Information

3.1	Introduction	11
3.2	Location of Status Indicators	11
3.3	Initial Start-Up	12

## Section 4

### Principles of Operation

4.1	Introduction	13
4.2	RF Input Signal	13
4.3	RF Output Load	13
4.4	Functional Description	13
4.4.1	Main RF Path	13
4.4.2	Loop Control	13
4.4.3	VSWR Protection	13
4.4.4	Thermal Protection	13
4.5	Amplifier Cooling	13

## TABLE OF CONTENTS (Continued)

Par. No.	Section 5 Maintenance	Page No.
5.1	Introduction	14
5.2	Periodic Maintenance	14
5.3	Cleaning Air Inlets/Outlets	14
5.4	Test Equipment Required for Test	15
5.5	Performance Test	15
	<b>Section 6 Troubleshooting</b>	
6.1	Introduction	16
6.2	Troubleshooting	16
6.3	Return for Service Procedure	17
6.3.1	Obtaining an RMA	17
6.3.2	Repackaging for Shipment	17
	<b>List of Illustrations</b>	
Figure		
1-1	C5 Series Amplifier, Front View	4
1-2	C5 Series Amplifier, Rear View	5
2-1	C5 Series Amplifier, Rear View Left	9
2-2	C5 Series Amplifier, Rear View Right	9
3-1	C5 Series Status Indicators, Front Panel	11
5-1	Amplifier Test Setup diagram	15
	<b>List of Tables</b>	
Table		
1-1	C5 Amplifier Functional Specifications	6
1-2	Frequency Ranges, Input/Output Power, Current, Spurious and Harmonics	7
2-1	Summary Alarm and Cutback Control Connections	10
3-1	C5 Series Amplifier Status Indicators	11
5-1	Periodic Maintenance	14
5-2	Test Equipment Required	15
6-1	Troubleshooting	16

# 1. GENERAL DESCRIPTION

## 1.1. INTRODUCTION

This manual contains information and procedures for installation, operation, and maintenance of Crescend's C5 Series Continuous Duty Power Amplifier. The manual is organized into six sections as follows:

- Section 1. General Description
- Section 2. Installation
- Section 3. Operating Instructions
- Section 4. Principles of Operation
- Section 5. Maintenance
- Section 6. Troubleshooting

## 1.2. PRODUCT DESCRIPTION

The Crescend Technologies C5 Series of RF power amplifiers are designed for trunking and conventional repeater applications. Rack mountable and designed to accept a range of input powers for a given rated output power, each amplifier covers a broad range of frequencies without retuning. Closed loop power control is used to maintain a constant output power under varying voltage, signal input, frequency and output load conditions. Several design features work to protect the amplifier under adverse conditions.

Designed to fit in 7 inches (4RU) of rack space, the C5 front panel includes status LED indicators for DC and Alarm conditions. RF Input, RF Output, DC, summary alarm and power cutback connections are found on the back of the amplifier. A rear mounted fan brings in air from the back and blows the air across the heat sink fins exiting out the sides of the amplifier. The fan is activated when the unit is powered.

Figures 1-1 and 1-2 show front and rear views of the C5 amplifier.

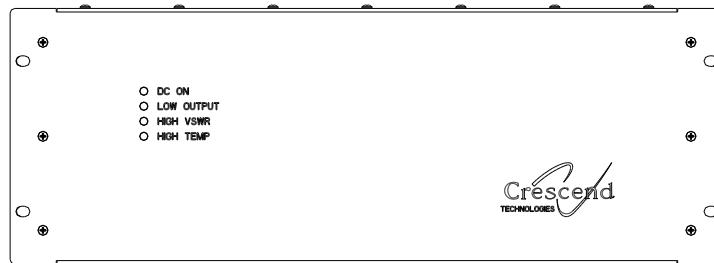

**Figure 1-1. C5 Series Amplifier, Front View**

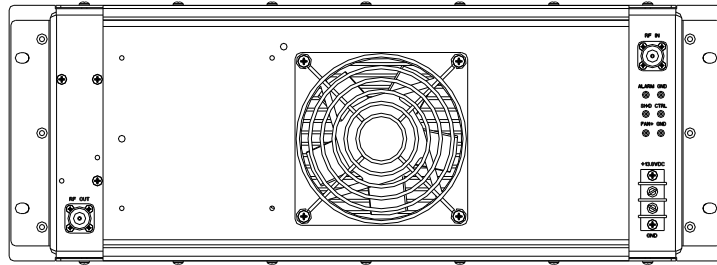

**Figure 1-2. C5 Series Amplifier, Rear View**

### **1.3. FUNCTIONAL AND PHYSICAL SPECIFICATIONS**

Functional and physical specifications for the C5 Series amplifiers are listed in Tables 1-1 and 1-2.

### **1.4. EQUIPMENT CHANGES**

Crescent Technologies, Inc. reserves the right to make minor changes without notice, including, but not necessarily limited to, component substitution and circuitry changes. Such changes may or may not be incorporated in this manual, although it is our intention to keep each manual as up-to-date as possible. To that end, we ask that you, our customer, share information with us acquired in field situations, which might be of assistance to another user.

**Table 1-1. C5 Series Amplifier Functional Specifications**

Frequency Range:	See Table 1-2 (Range Set at Factory)
Operating Voltage:	+48 ± 1.5 VDC
Current Consumption:	See Table 1-2
Duty Cycle:	100%
Power Input:	See Table 1-2 (Range Set at Factory)
Power Output (Single Carrier Operation):	See Table 1-2 (Range Set at Factory)
Input Return Loss:	-10 dB (Maximum)
Spurious & Harmonics:	See Table 1-2
Input/Output Impedance:	50 Ohms (Nominal)
Load VSWR Tolerance:	VSWR Protected above 2.5:1 (Nominal)
Input/Output Connector:	Type N Female
Vertical Mounting:	7.0 in
Horizontal Mounting:	19.0 in
Depth:	6.0 in
Weight:	10 lbs (4.6 kg) (Nominal)
Cooling Method:	Fan Forced Air Over Heat Sink
Operating Temp. Range:	-30°C to +60 °C
Storage & Transport:	-40 °C to +70 °C
Humidity:	80% at +40 °C (Non-Condensing)
Altitude:	10,000 Feet (Maximum)
Front Panel Display:	<b>INDICATORS</b> DC ON (Green), LOW OUTPUT (Red), HIGH VSWR (Red), OVER TEMP (Red)
Alarm and Control Pins:	<b>SUMMARY ALARM</b> Summary of Low Output, High VSWR, Over Temp Alarms  <b>CONTROLS</b> CTRL (Partial Power Cutback)

**Table 1-2. Frequency Ranges, Input/Output Power, Current, Spurious and Harmonics**

Frequency Range (MHz)	Input Power Range (W)	Rated Output Power (W)	Typ Current (A)	Max Current (A)	Spurious and Harmonics (dBc)
136-174 (DE)	0.1-0.2 0.2-0.5 0.5-1 1-2 2-5 5-10 10-20 20-50	250 (P25)	10.5	12.5	≤-70

**NOTES:** Manufacturer's Rated Output Power of this Equipment is for Single Carrier Operation.

All specifications above apply at +48 ± 0.5 VDC operating voltage, ambient temperature of 25°C ± 5°C.



## **2. INSTALLATION**

### **2.1. INTRODUCTION**

This section contains installation recommendations, unpacking, inspection, and installation instructions for the C5 Series of amplifiers. Carefully read all the material in this section prior to equipment unpacking or installation. Also read and review the operating procedures in Section 3 prior to installing the equipment. It is important that the licensee perform these tasks correctly and in good faith. If applicable, carefully read Parts 73 and 74 of the Federal Communications Commission (FCC) rules to determine how they apply to your installation.

### **2.2. ELECTRICAL SERVICE RECOMMENDATIONS**

Crescend Technologies recommends that proper AC line conditioning and surge suppression be provided on the primary AC input to the +48 VDC power source. All electrical service should be installed in accordance with the National Electrical Code, any applicable state or local codes, and good engineering practice. Special consideration should be given to lightning protection of all systems in view of the vulnerability of most transmitter sites to lightning. Lightning arrestors are recommended in the service entrance. Straight, short ground runs are recommended. The electrical service must be well grounded. Each amplifier should have its own circuit breaker.

### **2.3. UNPACKING AND INSPECTION**

This equipment has been operated, tested and calibrated at the factory. Only in the event of severe shocks or other mistreatment should any substantial readjustment be required. Carefully open the container(s) and remove the amplifier module(s). Retain all packing material that can be reassembled in the event that the unit must be returned to the factory.

**CAUTION:** Exercise care in handling equipment during inspection to prevent damage caused by rough or careless handling.

Visually inspect the amplifier module for damage that may have occurred during shipment. Check for evidence of water damage, bent or warped chassis, loose screws or nuts, or extraneous packing material in the connector or fans. Inspect the rear panel connector for bent connector pins. If the equipment is damaged, a claim should be filed with the carrier once the extent of any damage is assessed. We cannot stress too strongly the importance of IMMEDIATE careful inspection of the equipment and the subsequent IMMEDIATE filing of the necessary claims against the carrier if necessary. If possible, inspect the equipment in the presence of the delivery person. If the equipment is damaged, the carrier is your first area of recourse. If the equipment is damaged and must be returned to the factory, write or phone for a return authorization. Crescend may not accept returns without a return authorization. Claims for loss or damage may not be withheld from any payment to Crescend, nor may any payment due be withheld pending the outcome thereof. WE CANNOT GUARANTEE THE FREIGHT CARRIER'S PERFORMANCE.

## 2.4. INSTALLATION INSTRUCTIONS

The C5 amplifier is designed for installation in a rack that permits access to the rear of the rack for connection of DC power, RF, and monitor/control cables (see Figures 2-1 and 2-2). The amplifier must have a minimum of 3 inches of open space behind the rear fan to allow adequate ventilation.

To install the amplifier proceed as follows:

1. Install amplifier in equipment rack and secure in place.
2. Connect a 50 ohm antenna cable and load to the RF OUT connector on rear of amplifier.
3. Connect the transceiver/exciter output to RF IN connector on rear of amplifier.
4. If monitoring of PA is desired, connect alarm cable to "ALARM" pin on rear of amplifier module. See section 2.5 for more details.
5. If limited output power control of PA is desired, connect control cable or appropriate resistor to "CTRL" pin on rear of amplifier module. See section 2.5 for more details.
6. Measure primary DC input voltage. DC input voltage should be +48 +/- 0.5 VDC. Turn off DC voltage.

**WARNING:** Turn off external primary DC power before connecting DC power cables.

7. Connect positive primary power wire (+48VDC) to terminal marked +48VDC and negative primary power wire to GND terminal on rear of amplifier.
8. Check your work before applying DC voltage to the system. Make certain all connections are tight and the DC wires are going to the correct terminals.
9. Refer to Section 3 for initial start-up procedures.

NOTE:

1. Make sure power supply DC is well filtered and well behaved with minimal voltage overshoot.
2. Keep DC wires as short as possible to minimize inductance induced voltage transients.
3. Size DC Wires properly to handle the load current to minimize voltage drop.

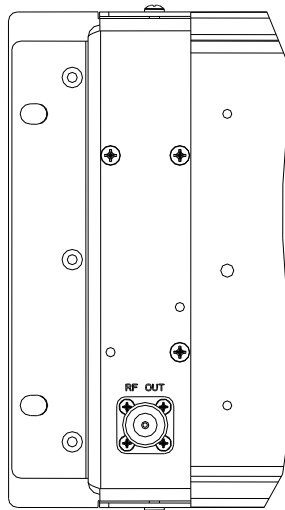

**Figure 2-1. C5 Series Amplifier, Rear View Left**

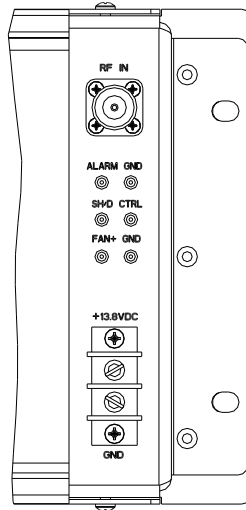

Figure 2-2. C5 Series Amplifier, Rear View Right

## 2.5. AMPLIFIER SUMMARY ALARM AND POWER CUTBACK CONTROL

The summary alarm and cutback control connections are made through separate filtered feedthrough connectors on the back of the amplifier (see Table 2-1).

Table 2-1. Summary Alarm and Cutback Control Connections

PIN	FUNCTION	DESCRIPTION	CONDITION	APPROPRIATE LOAD
ALARM	Summary Alarm	<p>“Open Collector” Output.</p> <p>Indicates when;</p> <ul style="list-style-type: none"> <li>- The output power is low,</li> <li>or</li> <li>- VSWR cutback is activated, or</li> <li>- Thermal cutback is activated.</li> </ul>	<p>Normal operation: The output is open (HIGH);</p> <p>Alarm: The output is closed (LOW).</p>	The voltage at the pin shall not exceed 50 V the incoming current shall not exceed 6 mA.
CTRL	External Power Control	It is possible to reduce the output power continuously by up to 4 dB by connecting a resistor between this pin and ground.	<p>Normal Operation – pin not connected.</p> <p>Power Control Mode – pin pulled to ground through resistor.</p>	Any resistor value, <100 pF

### 3. GENERAL OPERATING INFORMATION

#### 3.1. INTRODUCTION

This section contains operating instructions for the C5 amplifier.

#### 3.2. LOCATION OF STATUS INDICATORS

The location and function of the C5 amplifier status indicators is shown in Figure 3-1 and described in detail in Table 3-1.

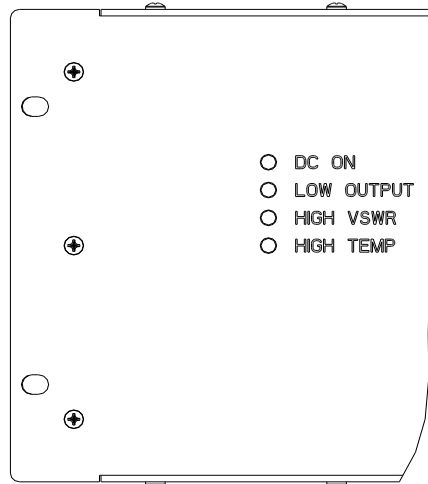

**Figure 3-1. C5 Series Status Indicators, Front Panel**

**Table 3-1. C5 Series Amplifier Status Indicators**

STATUS LED	FUNCTION
<b>DC ON</b>	Green LED. Illumination indicates DC Power has been applied.
<b>LOW OUTPUT</b>	Red LED. Activates when the output power drops to approximately 80-85% of set output power.
<b>HIGH VSWR</b>	Red LED. Activates when load VSWR exceeds approximately 2.5:1.
<b>HIGH TEMP</b>	Red LED. Activates when the amplifier exceeds a safe operating temperature.

### 3.3. INITIAL STARTUP

To perform the initial start-up, proceed as follows:

Check to ensure that all input and output cables are properly connected and tightened.

**Note:** Use high quality coaxial cable and connectors. Properly install and solder all connectors for reliability.

**CAUTION:** Before applying power, make sure that the input and output of the amplifier are properly terminated in 50 ohms. **Do not operate the amplifier without a load attached.** Refer to Table 1-2 for input power requirements. Excessive input power will damage the amplifier.

**NOTE:** The output coaxial cable between the amplifier and the antenna must be 50 ohm coaxial cable.

2. Apply DC power to the amplifier. Verify that the power supply measures  $48 \pm 0.5$  VDC. The fan will come on immediately.
3. Visually check the indicators on each amplifier module, and verify the following:
  - a. The DC PWR ON indicator (green) should be on.
  - b. All ALARM LED indicators (red) should be off.
4. Turn on external exciter/transceiver and apply RF input signal. The fan should turn on after approximately 3 seconds.
5. Turn off RF input signal. The fan should continue running.

## **4. PRINCIPLES OF OPERATION**

### **4.1. INTRODUCTION**

This section contains principles of operation of the C5 Series of RF Power Amplifiers.

### **4.2. RF INPUT SIGNAL**

The amplifiers are set at the factory to work over different input power ranges. The available range of inputs be found in Table 1-2.

### **4.3. RF OUTPUT LOAD**

The load impedance should be as good as possible (VSWR <1.2:1) in the working band for good power transfer to the load and maximum amplifier efficiency.

### **4.4. FUNCTIONAL DESCRIPTION**

The amplifier is a single channel CW amplifier that operates in the frequency band from 136 MHz to 174 MHz. The amplifier specifications are listed in Tables 1-1 and 1-2.

#### **4.4.1. MAIN RF PATH**

The typical main RF path consists of an input attenuator, driver, splitter, final stage(s), combiner, rf detectors and harmonic filter. The circuitry becomes active upon the sensing of rf input power. This occurs when rf input reaches approximately 3 dB below the low end of the input power range. This keeps standby current at a minimum (< 20 mA) when rf input is not present (or is below the turn on level).

#### **4.4.2. LOOP CONTROL**

The loop control circuitry works to maintain a constant output power versus variations in DC voltage, rf input power, frequency and load. A coupled detector at the output monitors the final RF output level and generates a DC voltage proportional to the RF output level. This voltage is fed back to the controller. The circuitry compares this voltage to a reference voltage and varies the gain of the amplifier to maintain a constant output.

#### **4.4.3. VSWR PROTECTION**

Reflected power is detected at the output of the amplifier and compared to forward power. When reflected power reaches an equivalent VSWR of approximately 2.5:1, the amplifier output is reduced to protect the finals and the front panel HIGH VSWR LED activates. The higher the load VSWR, the more the output power is reduced.

#### **4.4.4. THERMAL PROTECTION**

The heat sink temperature is monitored with a thermostat. When the heat sink temperature reaches an unsafe level, the output power of the amplifier is reduced by approximately 50%. This keeps the channel on the air while still providing some short term protection until the customer can address the underlying cooling issue.

### **4.5. AMPLIFIER COOLING**

The amplifier is cooled with forced air over a large heat sink. The fan, located on the rear of the amplifier and switched on when power is applied, draws ambient air in from the back of the amplifier and forces it over the heat sink. The rear baffle forces the air to run over the fins and exit on each side of the amplifier. It is important to maintain a minimum clearance of 3 inches behind the fan to allow the coolest air possible to circulate through the fan.

# **MAINTENANCE**

## **5.1. INTRODUCTION**

This section contains periodic maintenance and performance test information for the C5 Series. It also contains a list of test equipment required to perform various tests.

**NOTE:** Check your sales order and equipment warranty before attempting to service or repair the unit. Do not break the seals on equipment under warranty or the warranty will be null and void. Do not return equipment for warranty or repair service until proper shipping instructions are received from the factory.

## **5.2. PERIODIC MAINTENANCE**

Periodic maintenance requirements are listed in Table 5-1. Table 5-1 also lists the intervals at which the tasks should be performed.

**WARNING:** Wear proper eye protection to avoid eye injury when using compressed air.

**Table 5-1. Periodic Maintenance**

<b>TASK</b>	<b>INTERVAL</b>	<b>ACTION</b>
<b>Clean Air Vents/Check Fan</b>	30 Days	Inspect and clean per paragraph 5-3. Verify fan is working properly.
<b>Inspect Cables and Connectors and General Site Conditions</b>	6 Months	Inspect signal and power cables for frayed insulation and proper attachment. Check RF connectors to make sure that they are tight. Inspect the lightning protection system and ground at the site.

## **5.3. CLEANING AIR INLETS/OUTLETS**

The air inlets and outlets should be checked every 30 days and cleaned if necessary. If the equipment is operated in a severe dust environment, it should be checked and cleaned more often. If dust and dirt are allowed to accumulate, the cooling efficiency will be diminished. Using either compressed air or a brush with soft bristles, loosen and remove accumulated dust and dirt from the air inlet panels.

Check that the fan is running smoothly. A slow running or noisy fan may indicate an imminent fan failure. Replace immediately with a similar to insure long term reliability. Heat is one of the biggest factors in reducing the reliability of your amplifier. Make sure the fan has access to cool and clean airflow within the rack.

#### 5.4. TEST EQUIPMENT REQUIRED FOR TEST

Test equipment required to test the amplifier performance is listed in Table 5-2. Equivalent test equipment may be substituted for any item.

**NOTE:** All RF test equipment must be calibrated to 0.05 dB resolution. Any deviation from the nominal attenuation must be accounted for and factored into all output readings.

**Table 5-2. Test Equipment Required (or equivalent)**

EQUIPMENT	MANUFACTURER	MODEL
Signal Generator (1)	H.P.	8657B
30 dB Attenuator, 200 Watt (1)	Tenuline	8322
DC power supply (1)	H.P.	6032A
Spectrum Analyzer (1)	H.P.	8560E
Power Meter (1)	HP	E4418A
Power Meter (1)	HP	E4419A
Power Sensor (3)	HP	8481A
Pad (3)	Mini-Circuits	NAT-20
Coupler (2)	Narda	3020A
Coupler Load (1)		
Lab Amplifier (1)	AR	30W1000M7

#### 5.5. PERFORMANCE TEST

Performance testing may be conducted to ensure that the amplifier system meets the operational specifications listed in Tables 1-1 and 1-2. The test equipment required to perform the testing is listed in Table 5-2 and the test setup is shown in Figure 5-1.

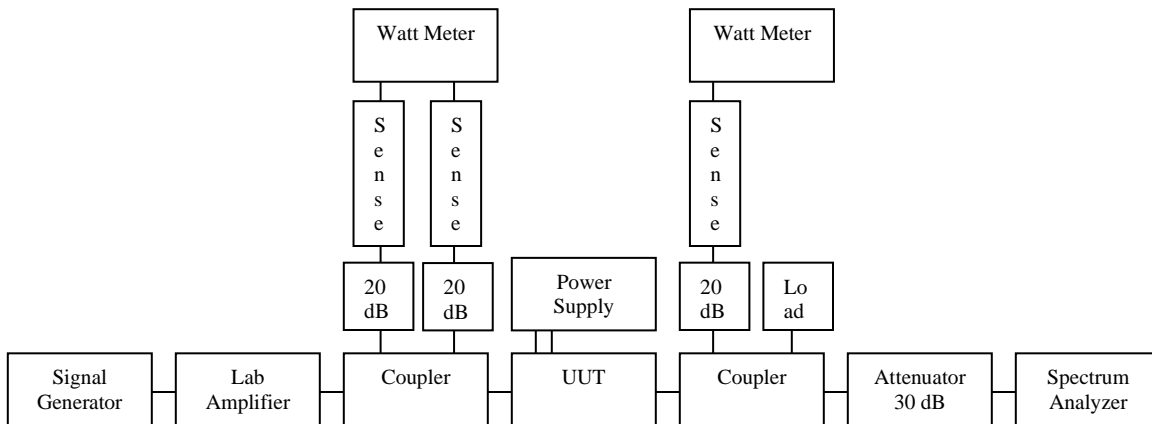

**Figure 5-1. Amplifier Test Setup Diagram**



## 6. TROUBLESHOOTING

### 6.1. INTRODUCTION

This section contains a list of potential problems and suggested actions to be taken. If the suggested corrective action does not eliminate the problem, please contact your Crescend factory for further instructions.

**NOTE:** Check your sales order and equipment warranty before attempting to service or repair the unit. Do not break the seals on equipment under warranty or the warranty will be null and void. Do not return equipment for warranty or repair service until proper shipping instructions are received from the factory.

### 6.2. TROUBLESHOOTING

Refer to Table 6-1 for troubleshooting suggestions. It has been found that in some cases it may be necessary to power cycle an amplifier (turn DC power off and back on without RF applied) to clear an alarm.

**Table 6-1. Troubleshooting**

INDICATOR	LED STATUS	OUTPUT POWER STATUS	POSSIBLE CAUSE	SUGGESTED ACTIONS
DC ON (Green)	Off	No power	No voltage at unit	1. Check power supply voltage
	On	Set power	Normal operation	2. No action required
LOW OUTPUT (Red)	On (all other alarm LEDs off)	Less than set power	Frequency is out of range	3. Check frequency
			The input power is below the low end of the rated input range	4. Check input power
			Power supply voltage is too low	5. Check power supply voltage at amplifier DC connector during key-up
	Problem inside amplifier		1. Send the unit back to factory	
	On (together with HIGH VSWR alarm LED)		Output load VSWR is much above 2.5:1	6. Turn off amplifier (or remove RF input) 7. Check output connections and cables for integrity and tightness. 8. Check antenna, combiner, etc. for proper return loss
HIGH VSWR (Red)	On	Less than set power	Output load VSWR is above 2.5:1	9. Turn off amplifier (or remove RF input) 10. Check output connections and cables for integrity and tightness. 11. Check antenna, combiner, etc. for proper return loss
OVER TEMP (Red)	On	Less than set power	Fan is not rotating	12. Check if +48 VDC is present on the FAN feedthrough pin when rf input present (after 3 sec turn on delay) 13. Check if anything is physically stopping rotation. 14. If fan has failed, replace fan with same or similar fan
			Power supply voltage is too low causing insufficient air flow	15. Check power supply voltage
			Operating temperature of amplifier is exceeding safe level. Note: When unit cools, LED turns off and output returns to rated power	16. Make sure that air access to front and rear of unit is unimpeded. 17. Verify that air vents are clear of dust and dirt and that fan(s) are operating properly. Replace fan if necessary. 18. Check ambient temperature (not to exceed spec - see Table 1-2)

### **6.3. RETURN FOR SERVICE PROCEDURES**

When returning products to Crescend, the following procedures will ensure optimum response.

#### **6.3.1. OBTAINING AN RMA**

A Return Material Authorization (RMA) number must be obtained prior to returning equipment to the factory for service. Please contact our Customer Service Department at 800-872-6233 to obtain this number. Failure to obtain this RMA number may result in considerable delays in receiving repair service.

#### **6.3.2. REPACKAGING FOR SHIPMENT**

To ensure safe shipment of the amplifier, it is recommended to use the packaging designed for the amplifier. The original packaging material is reusable. If it is not available, contact Crescend's Customer Service Department for packing materials and information.

---

THIS DEVICE COMPLIES WITH PART 15 OF THE FCC RULES. OPERATION IS SUBJECT TO THE FOLLOWING TWO CONDITIONS: (1) THIS DEVICE MAY NOT CAUSE HARMFUL INTERFERENCE, AND (2) THIS DEVICE MUST ACCEPT ANY INTERFERENCE RECEIVED, INCLUDING INTERFERENCE THAT MAY CAUSE UNDESIRE OPERATION.

---

This device complies with Industry Canada license-exempt RSS standard(s). Operation is subject to the following two conditions: (1) this device may not cause interference, and (2) this device must accept any interference, including interference that may cause undesired operation of the device.

---

Le présent appareil est conforme aux CNR d'Industrie Canada applicables aux appareils radio exempts de licence. L'exploitation est autorisée aux deux conditions suivantes : (1) l'appareil ne doit pas produire de brouillage, et (2) l'utilisateur de l'appareil doit accepter tout brouillage radioélectrique subi, même si le brouillage est susceptible d'en compromettre le fonctionnement.

---

NOTE: THE GRANTEE IS NOT RESPONSIBLE FOR ANY CHANGES OR MODIFICATIONS NOT EXPRESSLY APPROVED BY THE PARTY RESPONSIBLE FOR COMPLIANCE. SUCH MODIFICATIONS COULD VOID THE USER'S AUTHORITY TO OPERATE THE EQUIPMENT.